

GENERAL TOLERANCE ±0.1mm UNLESS SPECIFIED

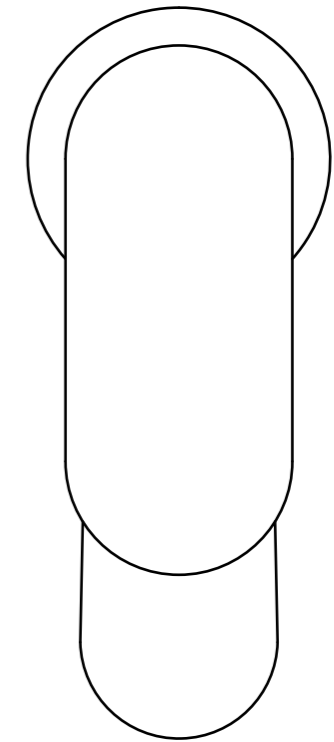

Flow Rate in LPM at			
0.5 BAR	1.0 BAR	2.0 BAR	3.0 BAR

SCALE -1:1

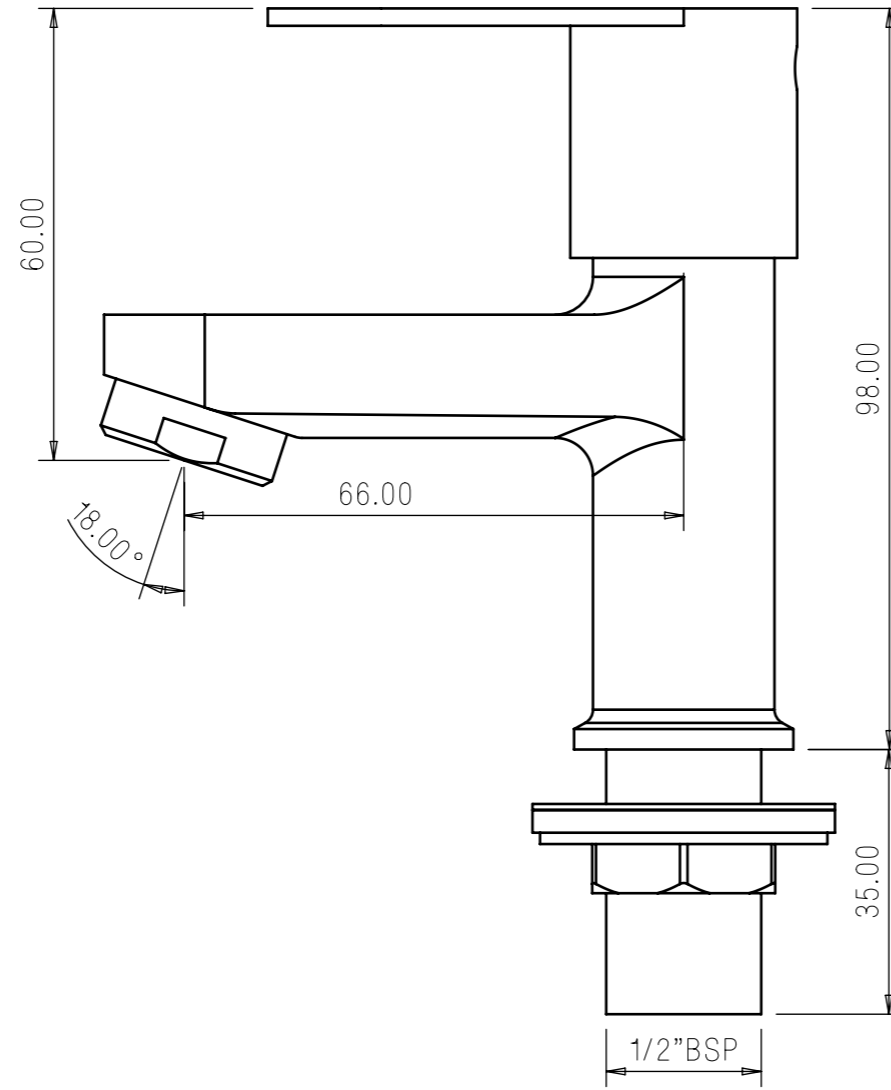
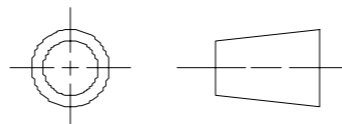

ALL DIMENSIONS IN MM

DRAWN BY	
CHECKED BY	
TYPE	

PRAYAG POLYMERS (P) LTD. A-1129, Phase-III, RIICO Indl.Area, Bhiwadi(Raj.)		
TITLE		
SIZE	PART NAME-	DATE
A3	CAT NO 5202	
MATERIAL	WEIGHT	

A3