

GENERAL TOLERANCE ±0.1mm UNLESS SPECIFIED

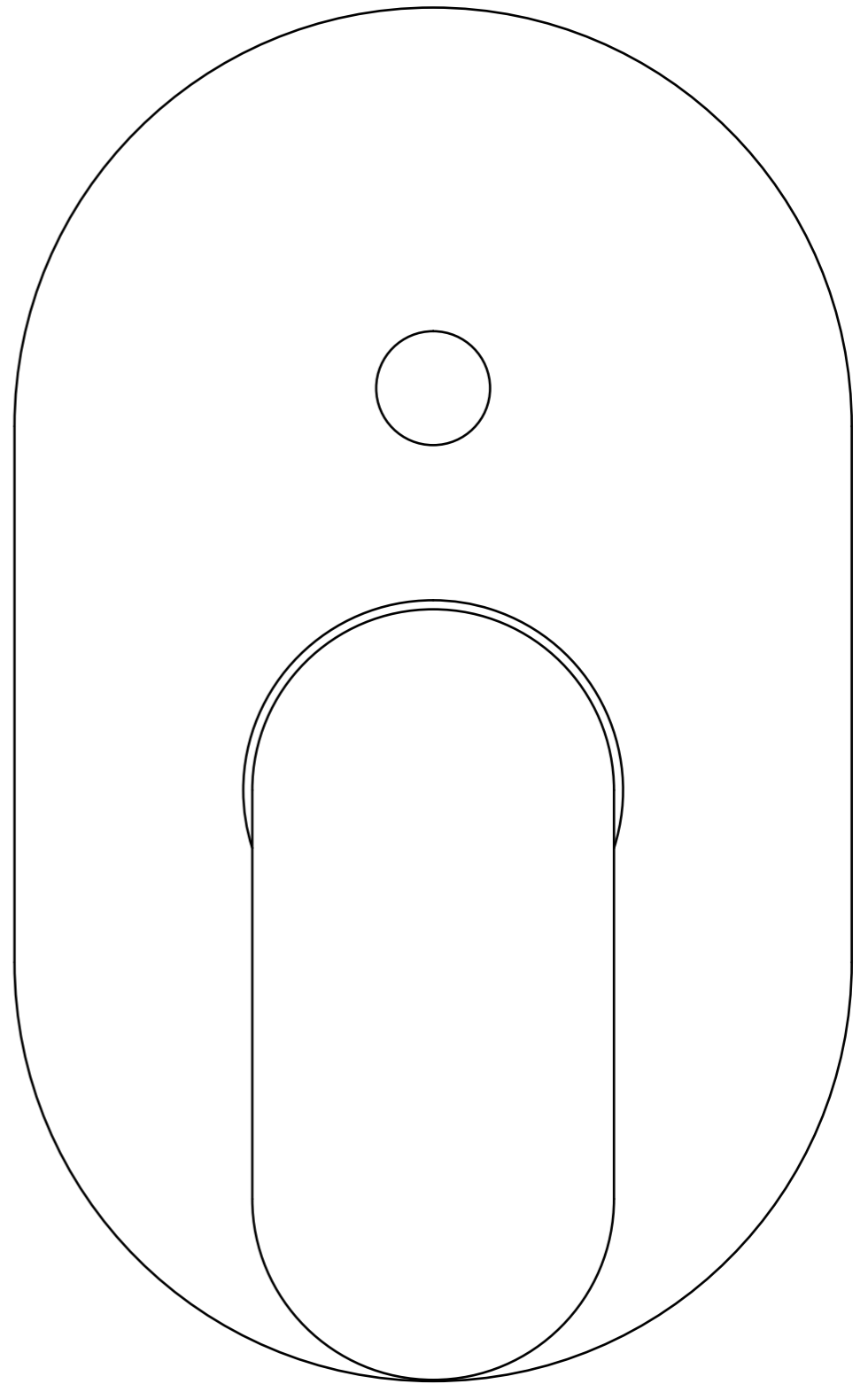

Flow Rate in LPM at			
0.5 BAR	1.0 BAR	2.0 BAR	3.0 BAR

SCALE -1:1

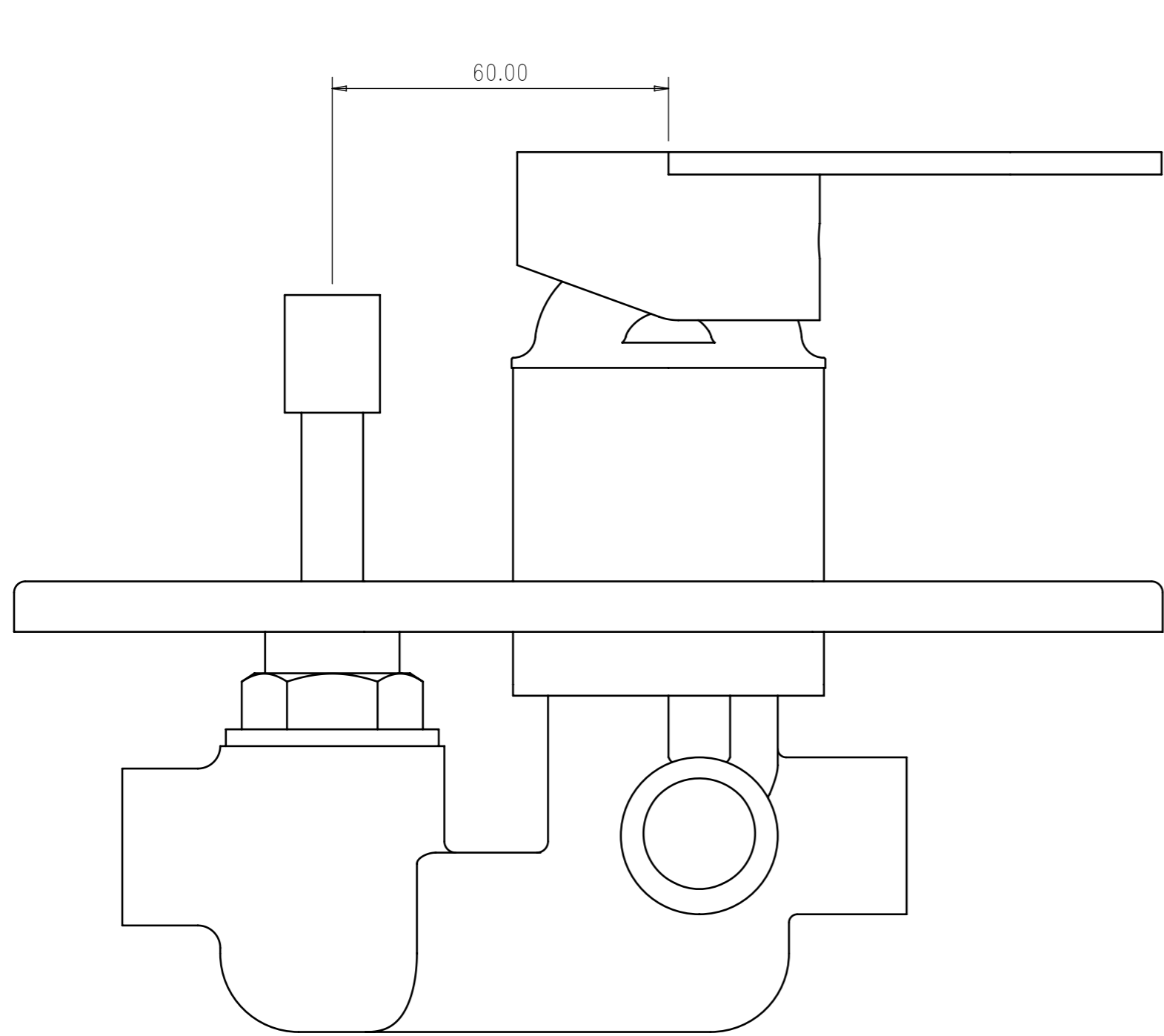
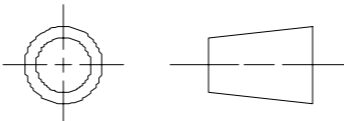

ALL DIMENSIONS IN MM

		PRAYAG POLYMERS (P) LTD.	
		A-1129, Phase-III, RIICO Indl.Area, Bhiwadi(Raj.)	
DRAWN BY		TITLE	
CHECKED BY		SIZE	DATE
TYPE		A3	CAT NO 7592
MATERIAL		WEIGHT	

A3